

- Fully ECE Approved
- Shock, Water and Dust Proof
- Exclusive LED Autolamps Design

- 12/24V Multivolt
- Low Current Draw
- Super Low-Profile

3M™
ADHESIVE
MOUNT SYSTEM

R10
ECE
APPROVED

IP67
100%
WATERPROOF

5
FIVE YEAR
WARRANTY

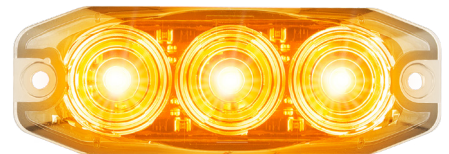
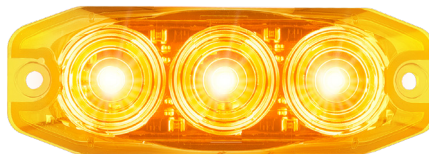
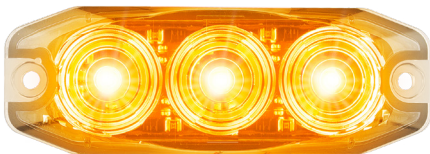
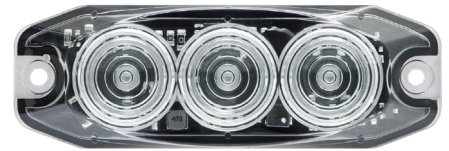
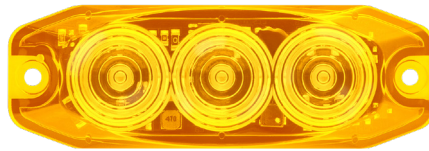
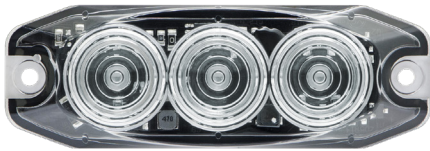

11ACM

Rear Indicator (Clear Lens)

Current Draw (13.8V/28V): 0.07A/0.05A

R6

ECE
APPROVED

11AM

Rear Indicator (Amber Lens)

Current Draw (13.8V/28V): 0.07A/0.05A

R6

ECE
APPROVED

11CAT1M

Front Indicator (Clear Lens)

Current Draw (13.8V/28V): 0.07A/0.05A

R6-C1

ECE
APPROVED

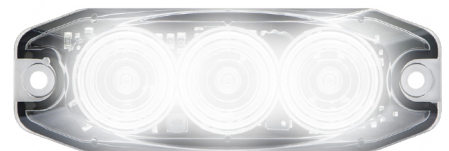
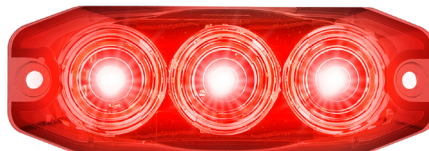
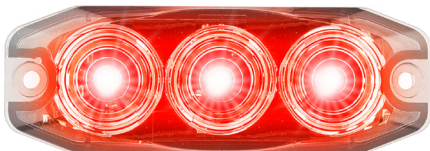
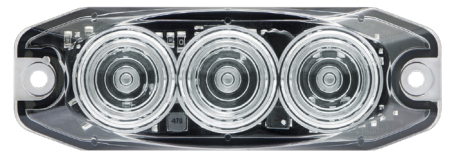
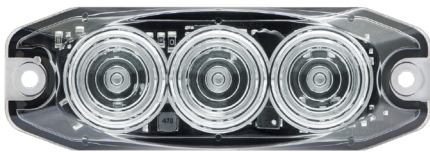

11FCM

Rear Fog (Clear Lens)

Current Draw (13.8V/28V): 0.19A/0.1A

R38

ECE
APPROVED

11FM

Rear Fog (Red Lens)

Current Draw (13.8V/28V): 0.19A/0.1A

R38

ECE
APPROVED

11WM

Reverse

Current Draw (13.8V/28V): 0.05A/0.04A

R23

ECE
APPROVED

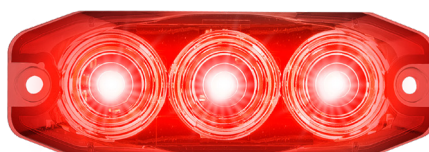
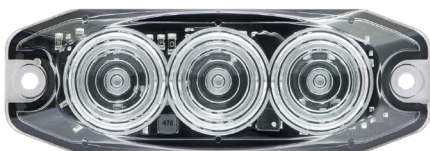

11RCM

Stop / Tail (Clear Lens)

Current Draw (13.8V/28V):
Stop: 0.05A/0.04A Tail: 0.01A/0.01A

R7

ECE
APPROVED

11RM

Stop / Tail (Red Lens)

Current Draw (13.8V/28V):
Stop: 0.05A/0.04A Tail: 0.01A/0.01A

R7

ECE
APPROVED

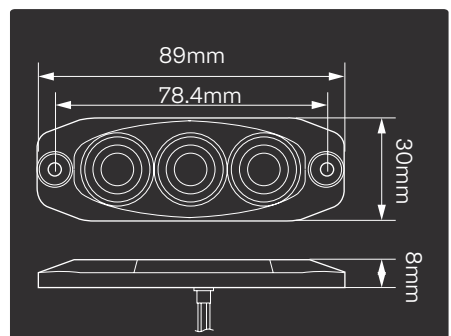

OVERALL DIMENSIONS 89 x 30 x 8mm

CABLE LENGTH 250mm